

TOP

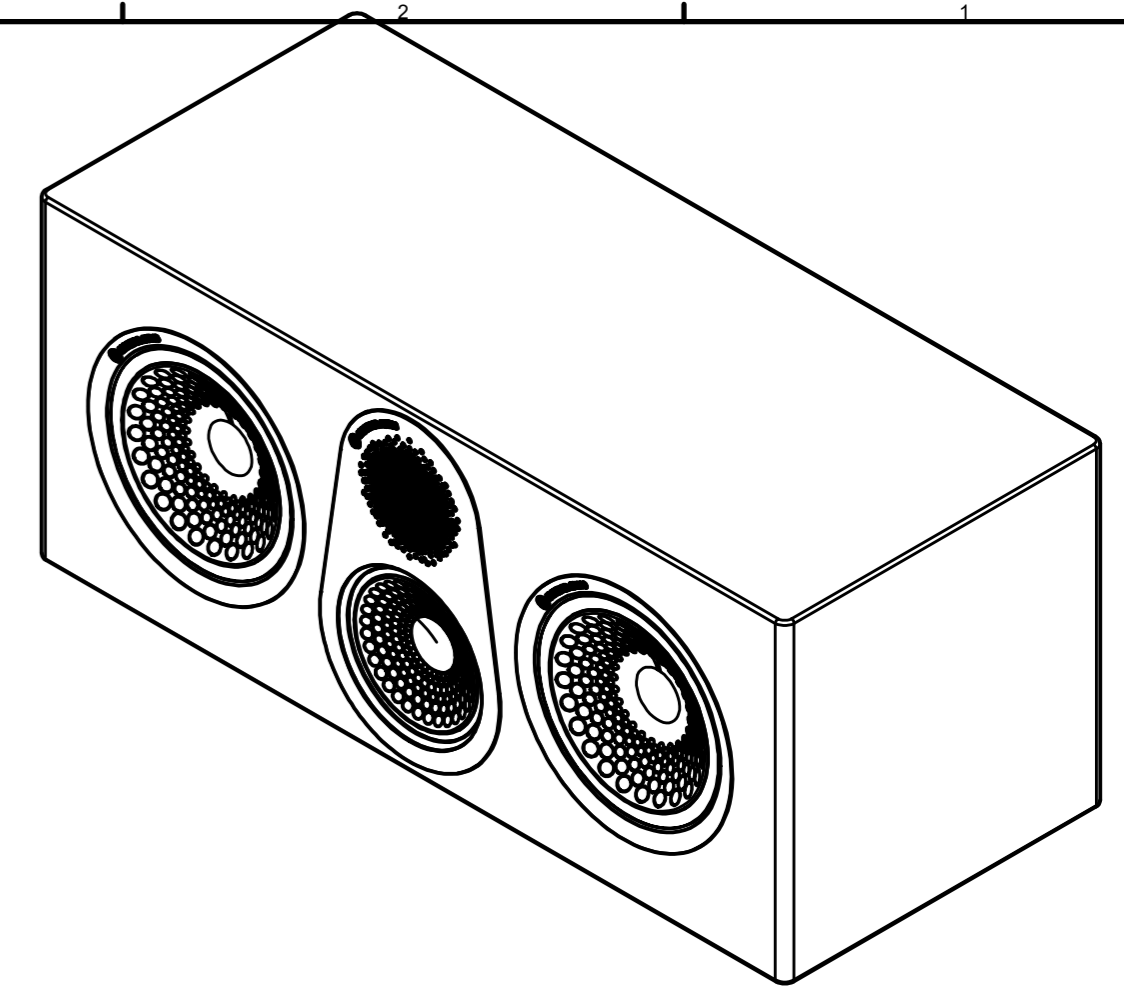

SIDE

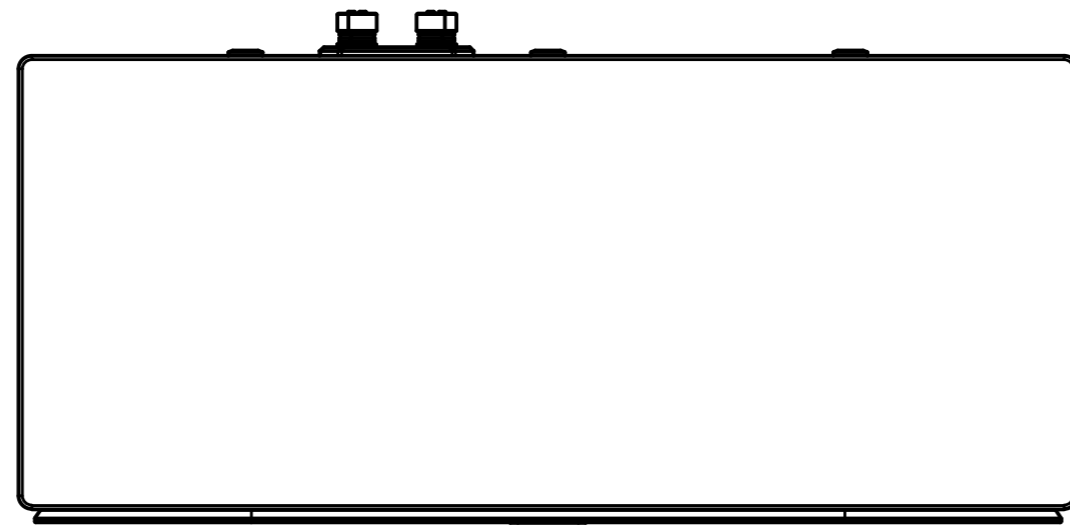
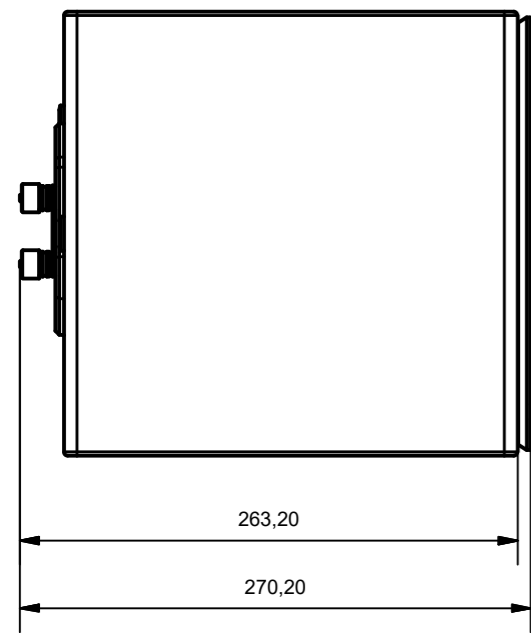

FRONT (WITH GRILLE)

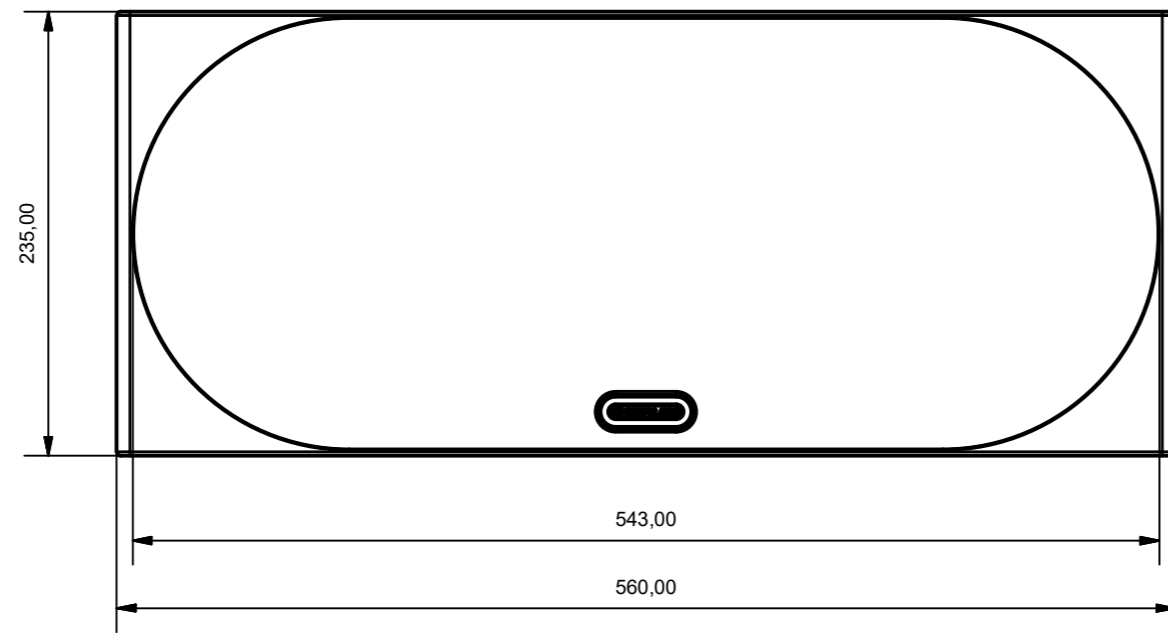

SIDE

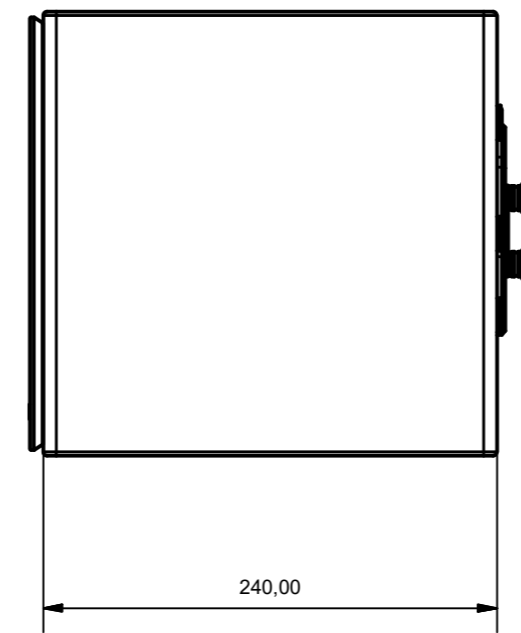

REAR

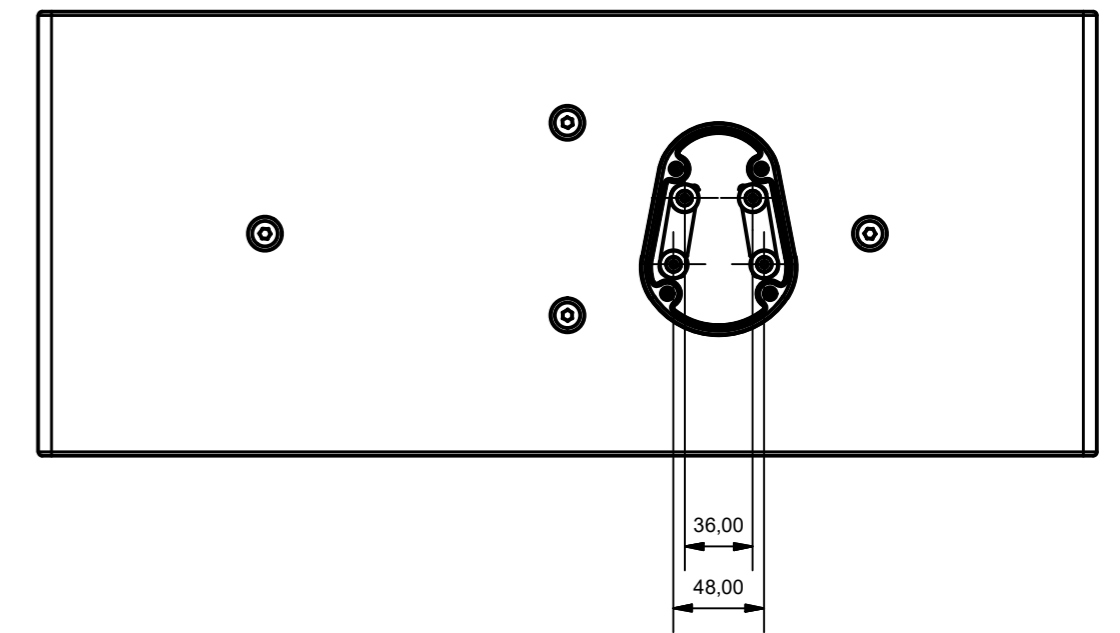

FRONT (NO GRILLE)

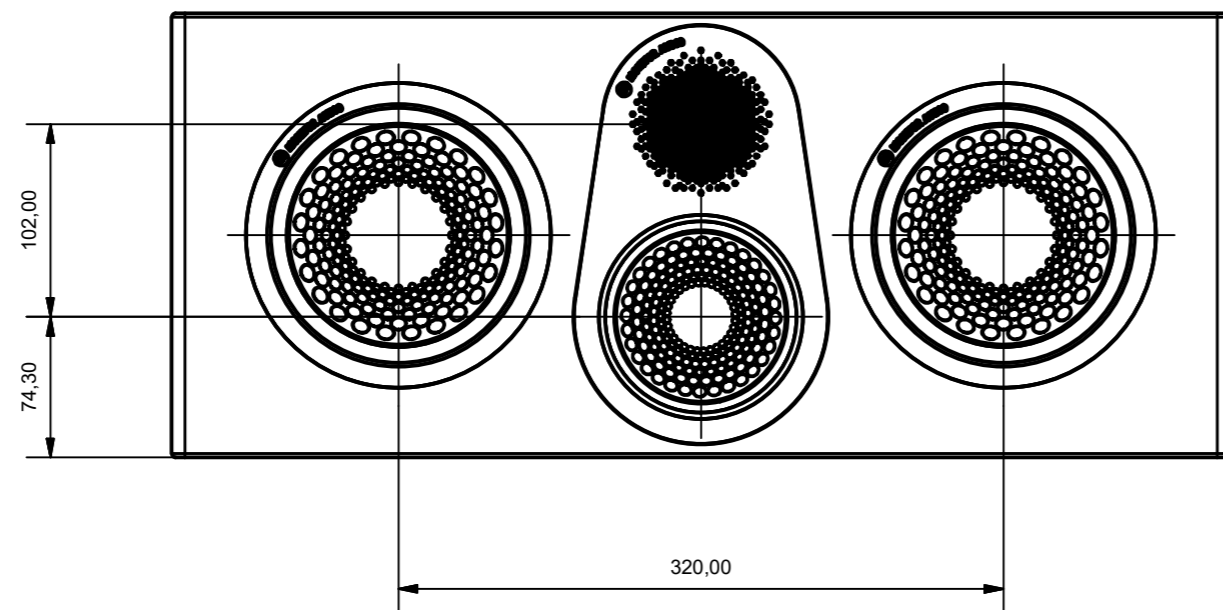

BASE

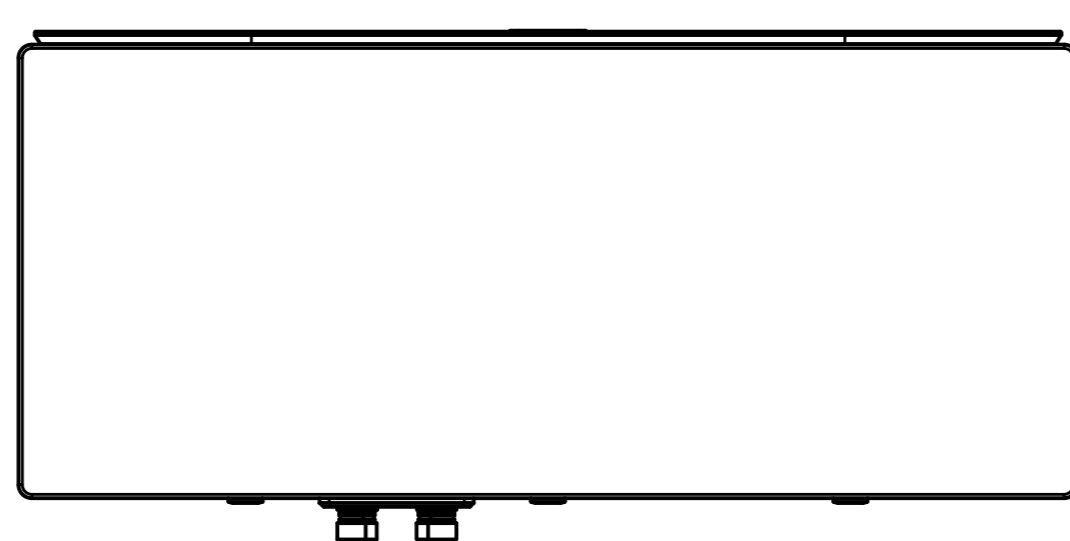

REVISION HISTORY				
REV	DESCRIPTION	DATE		
1	Drawing Creation	See Creation Date		
Notes: 1. DRAWINGS FOR CUSTOMER REFERENCE ONLY. 2. ALL DIMENSIONS ARE IN MM			Material	
			Part Volume (mm3)	N/A
			ALL DIMENSIONS IN MM	
			Tolerances: 0 Dec. Place ±0.5 1 Dec. Place ±0.2 2 Dec. Place ±0.1 Angles ± 1/2° Unless otherwise stated	
	Revision 1	Creation Date 13/03/2017	Designed by CEM	Checked by CEM
			Approved by RELEASED	
			SILVER SERIES 6G	
			S6G SILVER C350 CUSTOMER ASSEMBLY V1	Sheet 1 / 1