

B-SYSTEM

INSTALLATION SOLUTIONS

Price List

Valid from July 1, 2023

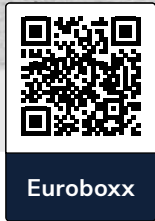

Euroboxx

Backbox for onsite concrete: ceiling installation backbox Euroboxx consisting of EPS base body with glued-in OSB back wall cover and OSB front panel (quartz bridge) with defined cut-out (120 mm-280 mm), acoustically optimized thanks to internal acoustic damping foam.

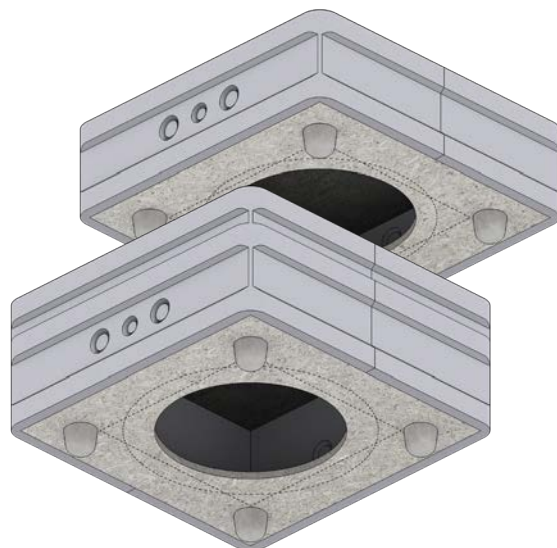

-  Concrete
-  Onsite Concrete
-  Exposed Concrete
-  Ceiling
-  Acoustics

i Also suitable for exposed concrete ceilings (face concrete)



Euroboxx 2nd Generation

Recommended
Retail Price
(excl. VAT)

SKU	Product	Volume	Dimensions	EUR
1012XXX	Euroboxx S	5.50 l	330 × 330 × 120 mm	109.00
1022XXX	Euroboxx M	8.50 l	330 × 330 × 160 mm	119.00
1032XXX	Euroboxx L	13.50 l	390 × 390 × 175 mm	129.00
1042XXX	Euroboxx XL	16.20 l	390 × 390 × 200 mm	189.00

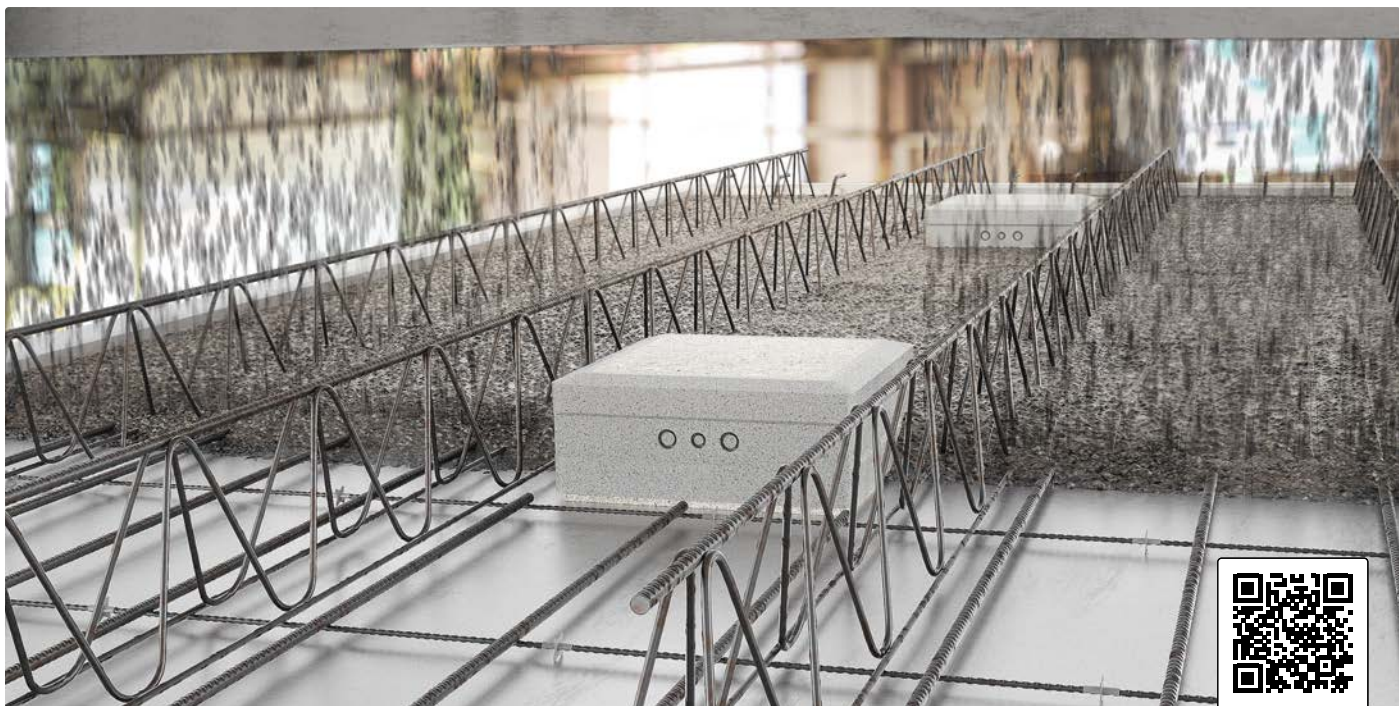



**Euroboxx
Precast**

Euroboxx Precast

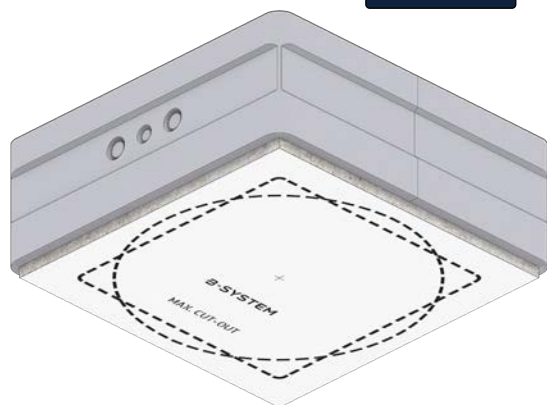
Universal installation backbox for prefabricated concrete ceilings, element ceilings and filigree ceilings: the Euroboxx Precast is an acoustically optimized backbox that can be integrated into the concrete slab right at the factory. For flexible planning and safe installation, the desired cut-out for the majority of installation loudspeakers can universally be made after completion.



- 
 Concrete
- 
 Filigree Ceiling
- 
 Prefabricated
Concrete Ceiling
- 
 Element Ceiling
- 
 Ceiling
- 
 Acoustics

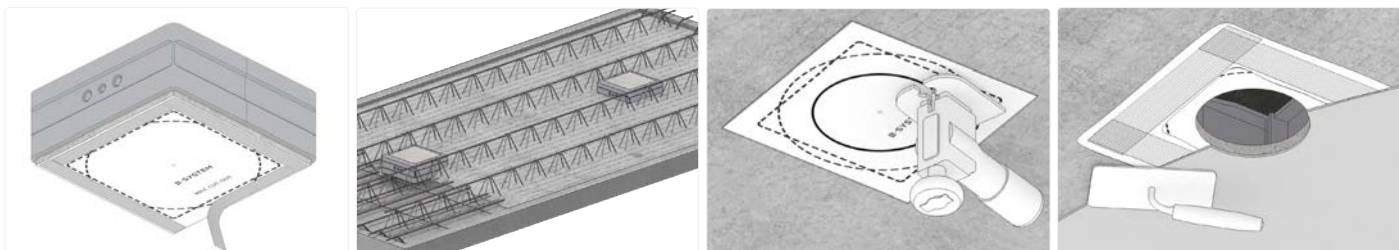

Euroboxx Precast

**Recommended
Retail Price**
(excl. VAT)

SKU	Product	Volume	Dimensions	EUR
1000402	Euroboxx L Precast	13.50 l	390 × 390 × 162.5 mm	169.00



Dryboxx

Dryboxx

Acoustically optimized wall and ceiling backbox for drywalls and suspended ceilings. Premium backbox made of high-quality MDF panels and interior insulation at studio level quality. Equipped with decoupling mat and ready for installation.

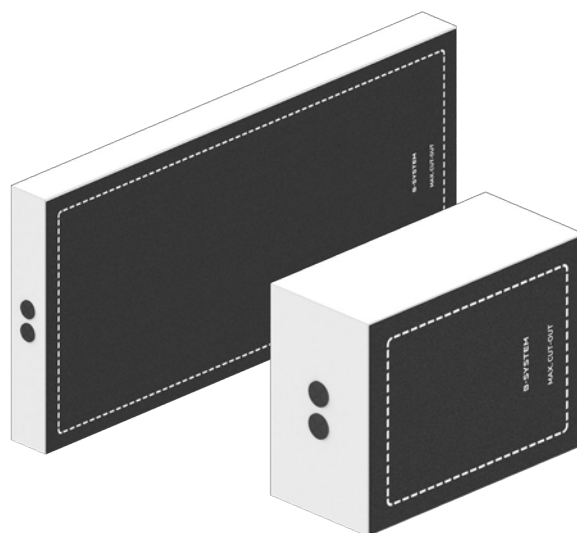

Dryboxx

Recommended
Retail Price
(excl. VAT)

SKU	Product	Volume	Dimensions	EUR
1000510	Dryboxx XS	8.80 l	430 × 330 × 97 mm	209.00
1000520	Dryboxx S	15.00 l	430 × 330 × 147 mm	229.00
1000530	Dryboxx M	21.20 l	430 × 330 × 197 mm	239.00
1000540	Dryboxx L	36.90 l	555 × 430 × 197 mm	279.00
1000550	Dryboxx wall XS*	15.30 l	555 × 430 × 97 mm	229.00
1000560	Dryboxx wall S*	24.40 l	670 × 555 × 97 mm	299.00
1000570	Dryboxx wall M*	33.40 l	910 × 555 × 97 mm	339.00
1000580	Dryboxx wall L*	42.50 l	1150 × 555 × 97 mm	379.00
1000999	Defined cut-out	On request, per backbox		30.00

* All Dryboxx wall backboxes suitable for both ceilings and walls.

B-SYSTEM GmbH
Bismarckstraße 19
D-78652 Deisslingen

Phone: +49 (0)7420 889 889
E-mail: info@b-system.com
Web: www.b-system.com

B-SYSTEM
INSTALLATION SOLUTIONS



Dryboxx retrofit

Acoustically optimized wall and ceiling backbox for retrofitting in drywalls and suspended ceilings. Installation backbox consisting of high-quality MDF panels and interior insulation at studio level quality. Ready for retrofit installation including CD profiles and screws.

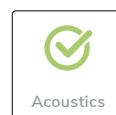
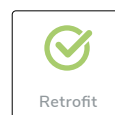
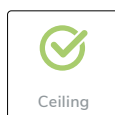
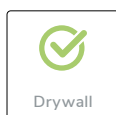
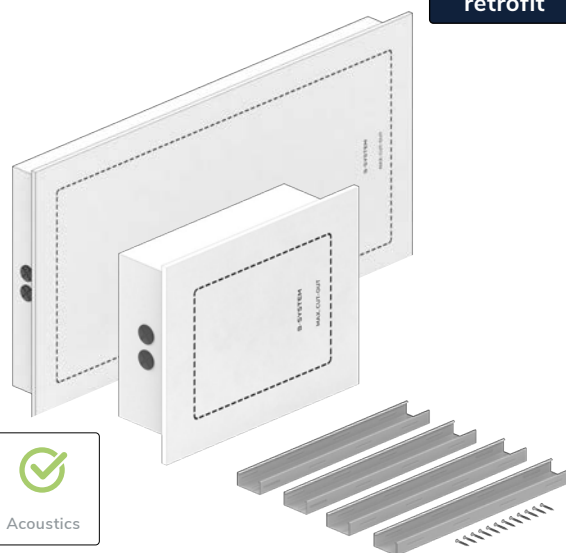

Dryboxx Retrofit

Recommended
Retail Price
(excl. VAT)

SKU	Product	Volume	Dimensions	EUR
1001510	Dryboxx XS retrofit	8.80 l	430 × 330 × 97 mm	289.00
1001520	Dryboxx S retrofit	15.00 l	430 × 330 × 147 mm	299.00
1001530	Dryboxx M retrofit	21.20 l	430 × 330 × 197 mm	319.00
1001540	Dryboxx L retrofit	36.90 l	555 × 430 × 197 mm	409.00
1001550	Dryboxx wall XS retrofit*	15.30 l	555 × 430 × 97 mm	359.00
1001560	Dryboxx wall S retrofit*	24.40 l	670 × 555 × 97 mm	429.00
1001570	Dryboxx wall M retrofit*	33.40 l	910 × 555 × 97 mm	469.00
1001580	Dryboxx wall L retrofit*	42.50 l	1150 × 555 × 97 mm	519.00
1000999	Defined cut-out	On request, per backbox		30.00

* All Dryboxx wall backboxes suitable for both ceilings and walls.



Dryboxx Invisible (Sonance)

Dryboxx Invisible (Sonance)

Especially developed for the Sonance Invisible series, acoustically optimized wall and ceiling installation backbox for drywall and suspended ceilings. Installation backbox consisting of high-quality MDF panels and internal insulation (acoustic damping foam) in studio level quality. Ready for installation and easy to mount including decoupling mat.

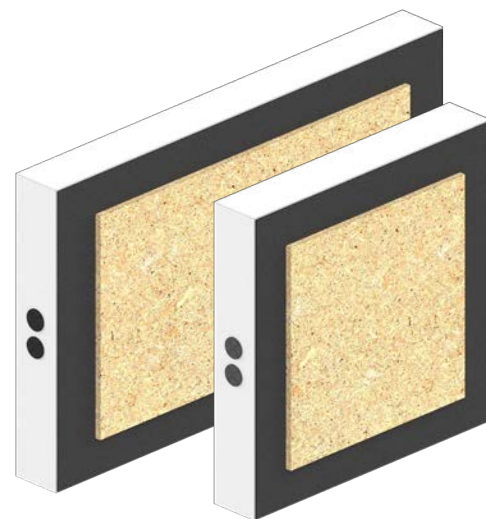

Dryboxx Invisible (Sonance)

Recommended Retail Price (excl. VAT)

SKU	Product	Volume	Dimensions	EUR
1501600	Dryboxx Invisible IS6	20.00 l	555 × 555 × 97 mm	349.00
1501400	Dryboxx Invisible IS8/ IS10W	24.35 l	670 × 555 × 97 mm	379.00
1501500	Dryboxx Invisible IS10	33.40 l	910 × 555 × 97 mm	429.00



Dryboxx
Invisible
(Stealth)

Dryboxx Invisible (Stealth)

Especially developed for the Stealth invisible speakers, acoustically optimized wall and ceiling installation backbox for drywall and suspended ceilings. Installation backbox consisting of high-quality MDF panels and internal insulation (acoustic damping foam) in studio level quality. Ready for installation and easy to mount including decoupling mat.



- 
-  Drywall
-  Ceiling
-  Wall
-  Vapour Barrier
-  Acoustics

Dryboxx Invisible (Stealth)				Recommended Retail Price (excl. VAT)
SKU	Product	Volume	Dimensions	EUR
1501470	Dryboxx Invisible Stealth S LR 6G, LRX-85 (Mid/Tweeter)	24.30 l	555 × 430 × 97 mm	319.00
1501460	Dryboxx Invisible Stealth M LR 8G, LRX-83, B 22G, SLR 8G	20.00 l	555 × 670 × 97 mm	379.00
1501480	Dryboxx Invisible Stealth L LR 3G, B 30G, LRX-85 (Woofer)	33.40 l	910 × 555 × 97 mm	429.00



Wallboxx

Universal installation backbox for concrete and brick walls: Wallboxx allows professional installations of in-wall speakers. Front and rear panels made of OSB (including quartz bridge), integrates seamlessly into the workflow for easy processing of the wall surface. The surrounding base body made of EPS is low-resonance and has sound-insulating properties.

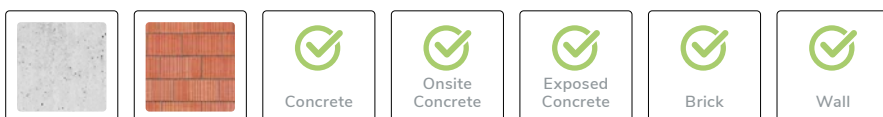

i Other custom sizes available on request at an additional fee

Wallboxx					Recommended Retail Price (excl. VAT)
SKU	Product		Volume	Dimensions	EUR
1000120	Wallboxx XS	Universal	6.30 l	390 × 290 × 120 mm	199.00
1000121	Wallboxx S	Universal	10.20 l	590 × 290 × 120 mm	209.00
1000148	Wallboxx M	Universal	9.90 l	435 × 390 × 120 mm	239.00
1000117	Wallboxx L	Universal	17.00 l	590 × 435 × 120 mm	249.00
1000215	Wallboxx L+	Universal	22.00 l	790 × 435 × 120 mm	269.00
1000118	Wallboxx XL	Universal	30.10 l	990 × 435 × 120 mm	289.00
1000301	Wallboxx XXL	Universal	43.30 l	1390 × 435 × 120 mm	319.00
1000999	Defined cut-out		On request, per backbox		30.00

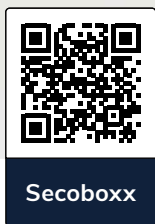

Secoboxx

Universal wall and ceiling backbox for suspended ceilings and drywall (protection). Installation backbox consisting of high quality acoustic panels. Ready for installation and easy to mount.

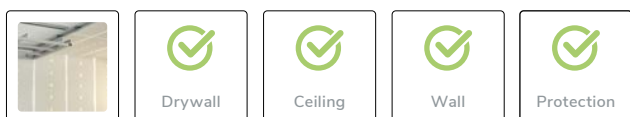
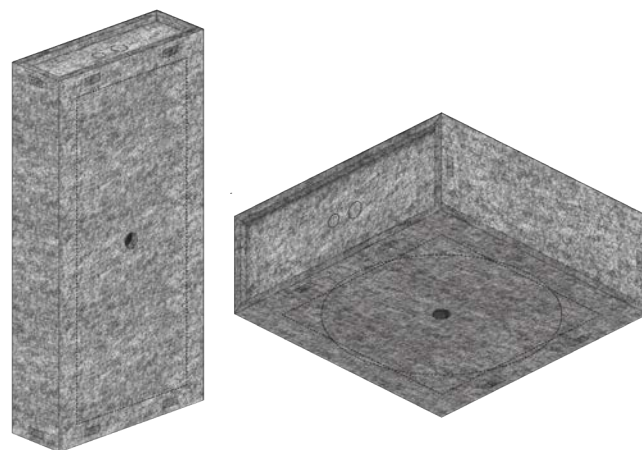

i Other custom sizes available on request at an additional fee

Secoboxx			Recommended Retail Price (excl. VAT)
SKU	Product	Dimensions	EUR
1000149	Secoboxx XS 2nd Generation	290 × 290 × 100 mm	99.00
1000150	Secoboxx S 2nd Generation	290 × 290 × 150 mm	109.00
1000151	Secoboxx M 2nd Generation	390 × 390 × 150 mm	139.00
1000152	Secoboxx L 2nd Generation	390 × 390 × 200 mm	159.00
1000153	Secoboxx wall XS*	590 × 290 × 100 mm	149.00
1000154	Secoboxx wall S*	790 × 390 × 100 mm	199.00
1000155	Secoboxx wall M*	990 × 390 × 100 mm	229.00
1000156	Secoboxx wall L*	1190 × 390 × 100 mm	299.00

* All Secoboxx wall backboxes suitable for both ceilings and walls.

gineos®

NEW:
for
SONOS
Era100



Gineos

Gineos®

Wall and ceiling installation kit for Sonos Era100, One, One SL, Play:1 and Denon Home 150 and Bluesound Pulse Flex 2i, BSP 200, as well as BSP 125. Gineos is a complete system including premium design covers in white or anthracite. The installation of Gineos in concrete ceilings, concrete walls or brick walls works with installation backboxes from B-System.

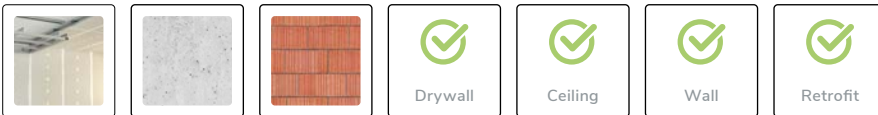

Gineos ONE

Recommended
Retail Price
(excl. VAT)

SKU	Product	EUR
	Gineos ONE (for Sonos Era100, One, One SL and Play:1, and Denon Home 150)	
1051000	Gineos ONE (circular, white)	159.00
1052000	Gineos ONE (circular, anthracite)	159.00
1051500	Gineos ONE (square, white)	159.00
1052500	Gineos ONE (square, anthracite)	159.00
	Gineos ONE (Bluesound Edition; for Pulse Flex 2i, BSP 200, BSP 125)	
1051010	Gineos Bluesound Edition (circular, white)	159.00
1051020	Gineos Bluesound Edition (circular, anthracite)	159.00
1051030	Gineos Bluesound Edition (square, white)	159.00
1051040	Gineos Bluesound Edition (square, anthracite)	159.00
1022220	Euroboxx M: Gineos backbox for concrete ceilings / concrete walls	119.00
1022221	Euroboxx M wall: Gineos backbox for concrete walls / brick walls	119.00

Extension Kit



Accessory for bridging different ceiling mounting heights with installation loudspeakers (with too little clamping heights) in combination with installation backboxes from B-System.

i The B-System Extension Kit is suitable for the majority of all installation loudspeakers from 6 inch diameter or larger. Testing required on a case-by-case depending on the specific speaker model.

Extension Kit			Recommended Retail Price (excl. VAT)
SKU	Product	Dimensions	EUR
1000168	Extension set (4 units)	30 mm - 75 mm	42.00
1000169	Extension set (4 units)	70 mm - 115 mm	45.00

Your Custom Backbox

In addition to our wide range of standard products, we also offer customized solutions for special requirements and project inquiries.

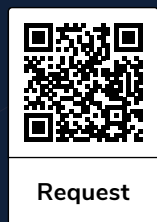

Your request



We plan



Our offer



Advisory Services & Ordering

- ✓ Individual consultation by email and phone
- ✓ Multilingual support
- ✓ Key account contact in the B-System team
- ✓ Order online, by email or phone
- ✓ Documents and videos for planning and installation

Worldwide Shipping

- ✓ Express shipping available
- ✓ Worldwide shipping by UPS with tracking code
- ✓ Worldwide shipping by shipping partners (pallets)
- ✓ Shipment within 1-3 business days after receipt of order
- ✓ Attractive flat shipping rates, free shipping possible



Infrastructure

- ✓ Access to custom designs and special solutions
- ✓ Smooth workflows due to digital processes
- ✓ All products permanently in stock in large quantities
- ✓ Attractive payment conditions in Euro
- ✓ Liability insurance (10 million € amount insured))

Marketing & Sales Support

- ✓ Access to media content
- ✓ Access to digital planning documents and 3D data
- ✓ Access to B-System Backbox Finder platform
- ✓ Support for marketing activities
- ✓ Possibility of presentation on B-System website



Warehouse
3,000 sqm



Shipping
Worldwide



Tools
Backbox Finder



Warranty
3 Years



Consultation
Individual

Quality



Made in Germany

Installation Backboxes from B-System

About Our Solutions:

- Our backboxes support the audio quality of custom install speakers and unwanted sound propagation in the building (air-borne noise) is significantly reduced.
- Our system architecture allows for a wide range of options, even for demanding applications such as exposed concrete ceilings or brick walls.
- Our backboxes protect loudspeakers and technology from dirt, moisture, dust and insects.
- High-quality and robust components used
- Versatile standard program suitable for all common loudspeaker brands and models
- Standardized and well-known products and installation workflows
- Numerous documents such as data sheets and installation instructions available for each product
- Personal consultation from the B-System team
- Products in use thousands of times for years - worldwide!

Easily find the right backbox for your loudspeakers:

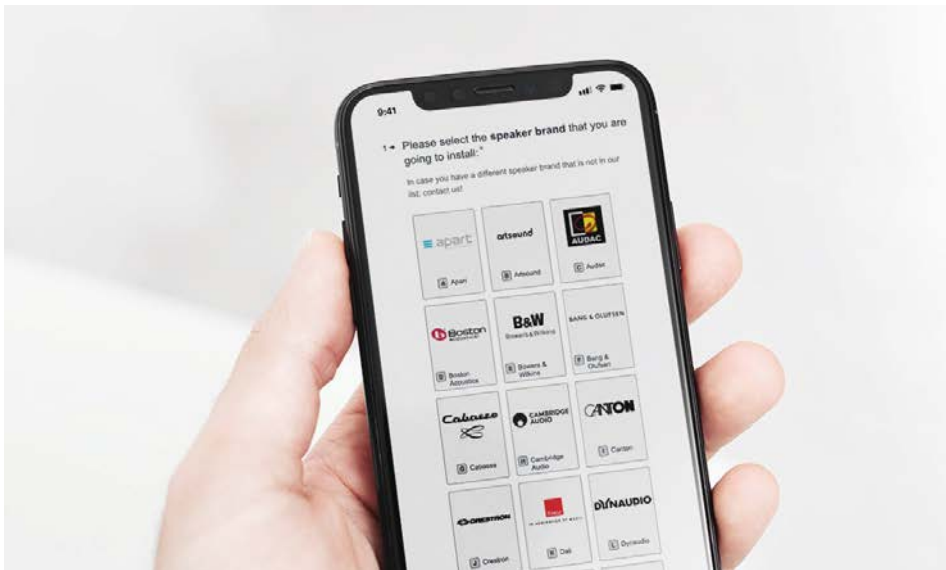

Backbox
Finder

All prices net (excl. VAT, excl. shipping) ex works
Valid from July 1, 2023

Shipping within EU:

0 - 2,500 EUR: shipping costs flat rate per order
from 2,500 EUR: free shipping

Note on deliveries to third countries:

B-System GmbH does not cover any import duties or import taxes raised at the shipping destination or customs. If these are charged to B-System GmbH, they will be passed on to the client.

B-SYSTEM

INSTALLATION SOLUTIONS

B-SYSTEM GmbH
Bismarckstraße 19
78652 Deisslingen
Germany

Phone: +49 (0)7420 889-889
E-mail: info@b-system.com
Web: www.b-system.com